

INSTALLATION AND CARE GUIDE

WILSON AUDIO
SUBSONIC™

2 Wilson Audio Subsonic Installation Guide

Wilson Audio® is a registered trademark of Wilson Audio Specialties, Inc.

Sophia®, Sasha W/P®, WAMM®, MAXX®, XLF®, and Alexandria® are registered trademarks of Wilson Audio Specialties, Inc.

WAMM Master Chronosonic™, WAMM Master Subsonic™, Alexx™, Sabrina™, Alida™, Alexia™, WilsonGloss™, Wilson Audio Duette™, WATCH Center™, WATCH Surround™, WATCH Dog™, and Thor's Hammer™ are trademarks of Wilson Audio Specialties, Inc.

This manual was produced by the Wilson Audio Engineering and the Marketing Department. The information contained herein is subject to change without notice. Current Revision 1.0. If you are in need of a more recent manual, please contact your dealer or download one at www.wilsonaudio.com.

The information in this manual is the sole property of Wilson Audio Specialties, Inc. Any reproduction, in whole or in part, without the express written permission of Wilson Audio Specialties, Inc., is prohibited. No material contained herein may be transmitted in any form or by any means, electronic or mechanical, for any purpose, without the express written permission of Wilson Audio Specialties, Inc.

Copyright © 2017 Wilson Audio Specialties

CONTENTS

SECTION 1—UNCRATING 7

 SECTION 1.1—WILSON AUDIO SUBSONIC CRATE CONTENT 8

 SECTION 1.2—PREPARATION..... 8

 UNCRATING THE WILSON AUDIO SUBSONIC..... 9

SECTION 2—INITIAL SETUP..... 11

 SECTION 2.1—MOVE THE WILSON AUDIO SUBSONIC INTO POSITION..... 12

 SECTION 2.2—CONNECTING THE CONTROLLER..... 13

 CONNECT THE CONTROLLER TO THE WILSON AUDIO SUBSONIC AMPLIFIER.. 13

 BYPASSING THE HIGH PASS FILTER..... 14

 UTILIZING THE HIGH PASS FILTER 15

SECTION 3—CONTROLLER FINAL SETUP..... 19

 SECTION 3.1—FRONT PANEL SETUP AND FINAL TUNING..... 20

 PREPARATION..... 20

 SECTION 3.2—NOTES FROM DAVID A. WILSON ON THE TEST CD 21

 WILSON AUDIO SUBSONIC PLACEMENT 21

 FILTERING OF LF TO THE LEFT & RIGHT SPEAKERS..... 22

4 Wilson Audio Subsonic Installation Guide

INITIAL PLACEMENT OF THE L & R SPEAKERS.....	22
NOTES REGARDING THE INTERPRETATION OF MEASUREMENTS	24
USING THE HIGH PASS FILTER.....	25
THE CONTROLLER INTO YOUR SYSTEM.....	26
TO EQ OR TO NOT EQ.....	29
SECTION 3.3—BREAK-IN PERIOD.....	32
SECTION 3.4—TWELVE-VOLT TRIGGER CONTROLS	32
SECTION 4—FINISHING UP	37
SECTION 4.1— SPIKE INSTALLATION, HORIZONTAL.....	38
PLINTH AND SPIKE INSTALLATION.....	39
ASSEMBLY AND CARE OF THE GRILLS.....	40
SECTION 4.2—SPIKE INSTALLATION, VERTICAL.....	40
SPIKE ASSEMBLY.....	40
SECTION 4.3—USING THE LIFT TO INSTALL SPIKES.....	41
MATERIALS REQUIRED	41
INSTALLATION PROCEDURE.....	42
LEVELING THE WILSON AUDIO SUBSONIC	43
SECTION 4.4—REMOVING THE PROTECTIVE FILM	44

SECTION 5—SPECIFICATIONS 49

 SECTION 5.1—SPECIFICATIONS: WILSON AUDIO SUBSONIC 50

 SECTION 5.2—GRAPHICAL DIMENSIONS: WILSON AUDIO SUBSONIC 51

 SECTION 5.3—SPECIFICATIONS: CONTROLLER 52

 SECTION 5.4—GRAPHICAL DIMENSIONS: CONTROLLER 53

SECTION 6—WARRANTY 55

 SECTION 6.1—LIMITED WARRANTY 56

 SECTION 6.2—CONDITIONS 56

 SECTION 6.3—REMEDY 57

 SECTION 6.4—WARRANTY LIMITED TO ORIGINAL PURCHASER 58

 SECTION 6.5—DEMONSTRATION EQUIPMENT 58

 SECTION 6.6—MISCELLANEOUS 59



SECTION 1—UNCRATING

8 Wilson Audio Subsonic Installation Guide

Section 1.1—Wilson Audio Subsonic Crate Content

Note: To avoid damaging the Yvette’s painted surface. Please remove any jewelry such as rings, watches, necklaces, and bracelets during this process.

Please take the time before you attempt to setup up your Wilson Audio Subsonic to review the contents of your Wilson Audio Subsonic tool and spike kit. Set these items in an accessible area as you will need them during the setup process. See the two graphics below:

Section 1.2—Preparation

You will need the following items:

- Supplied hardware kit
- Electric screwdriver or battery-operated drill
- Phillips head drive bit

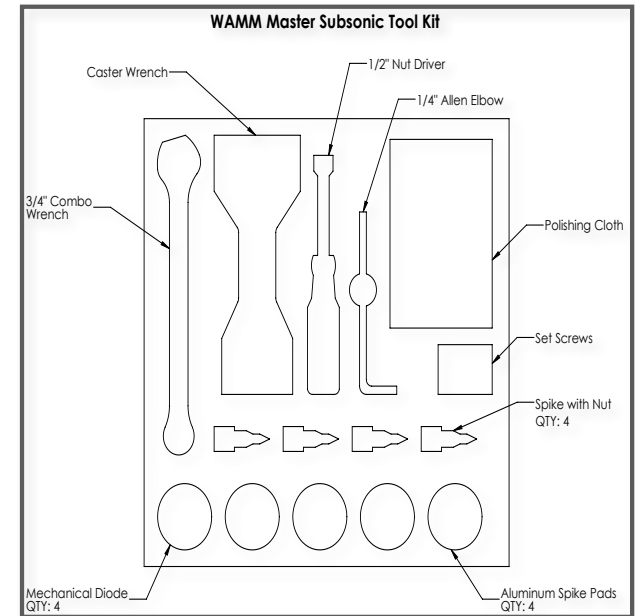

Uncrating the Wilson Audio Subsonic

A minimum of three strong adults are required to set up the Wilson Audio Subsonic. The Wilson Audio Subsonic weighs over six hundred pounds, and care should be taken to prevent injury.

1. With the crate lid facing up, unscrew the wood screws securing the lid. Remove the lid. Remove the foam packing material that is positioned between the casters (on the bottom of the Wilson Audio Subsonic). The Wilson Audio Subsonic will not roll out of the crate with this packing material in place.
2. Carefully rotate the crate so that the Wilson Audio Subsonic is upright.
3. While one person holds the crate, the other two helpers should gently roll the Wilson Audio Subsonic out of the crate. Be careful not to scratch the sides of the painted enclosure.
4. Move the Wilson Audio Subsonic into the desired location. It is recommended that you leave the casters attached to the bottom of the Wilson Audio Subsonic during the positioning process.

Note: Be careful not to touch the driver elements when you are moving your Wilson Audio Subsonic!



SECTION 2—INITIAL SETUP

Section 2.1—Move the Wilson Audio Subsonic Into Position

The Wilson Audio Subsonic is shipped with casters installed on the bottom of the cabinet. Leave the casters on the Wilson Audio Subsonic as you move it to its desired location. Wilson Audio Subsonic can be installed either vertically or horizontally. If the intent is to install it vertically, leave the casters on as you proceed with the setup.

Note: If you are installing the Wilson Audio Subsonic horizontally, remove the casters before tipping it onto its side. Also, make sure you orient Wilson Audio Subsonic such that the connectors are positioned on the side that best accommodates cable installation.

Because the Wilson Audio Subsonic's frequency range is limited to the sub-frequency bass range, its placement requirements are fundamentally different than for a full frequency speaker. The Wilson Audio Subsonic reproduce a relatively small percentage of the audio spectrum, with a typical bandwidth of less than two octaves. The strategy for placing a subwoofer can be centered around bass optimization; the room's effect on the midrange and treble can be largely disregarded. When used with the Wilson Audio Controller, placement flexibility of Wilson Audio Subsonic is further enhanced.

The ideal position of the Wilson Audio Subsonic subwoofer is somewhat dependent on its primary use.



Section 2.2—Connecting the Controller

Connect the Controller to the Wilson Audio Subsonic Amplifier

The “LOW PASS OUT” connectors labeled “1” and “2” are the output signal connectors for the subwoofer amplifier. The Controller sums the left and right channels so both “1” and “2” outputs contain identical signals. There is a single-ended and a balanced connector for each output. If you are using one subwoofer, connect the amplifier driving the subwoofer to the Controller’s “LOW PASS OUT” via the “1” output. Choose either the balanced cable or single-ended output to match the input configuration of the amplifier.

If you are using two subwoofers with separate amplifiers, connect the second amplifier channel to the “2” output. By using “Y” connectors (contact your Wilson dealer for details), you can connect the controller to more than two subwoofer amplifiers.

14 Wilson Audio Subsonic Installation Guide

Bypassing the High Pass Filter

In systems where the main speakers are full-range, the subwoofer used with the controller can be configured more successfully without the use of the High Pass filter. There is a normal bass roll-off that occurs naturally in your listening room. This effect acts like a six dB per octave low pass filter and rolls off the bass from your main speakers. In most systems it is not necessary or desirable to use the High Pass filter. The WATCH Dog Controller's Low Pass filter controls, in conjunction with the Bass Equalization and Phase controls (discussed in Section 3), will allow you to successfully integrate the main loudspeakers with the subwoofer without the use of the High Pass filter.

Make sure the Controller power is off during the connecting process. Locate the input section of the Controller on the rear of the unit. Controller inputs are configured for both balanced (XLR) and single-ended (RCA) cables.

When connecting the Controller without the use of the High Pass Filter, a second output from your preamplifier is required. If your preamplifier does not have two sets of outputs, consult with your Wilson dealer about using high quality "Y" connectors to facilitate connecting your unit. From one of the preamp outputs, connect your preamp directly to your main amplifier. From a second set of preamp outputs, connect both left and right channels to the Line Level Input of the Controller. The Controller automatically sums the information from the left and right channels when the controller is used with stereo inputs.

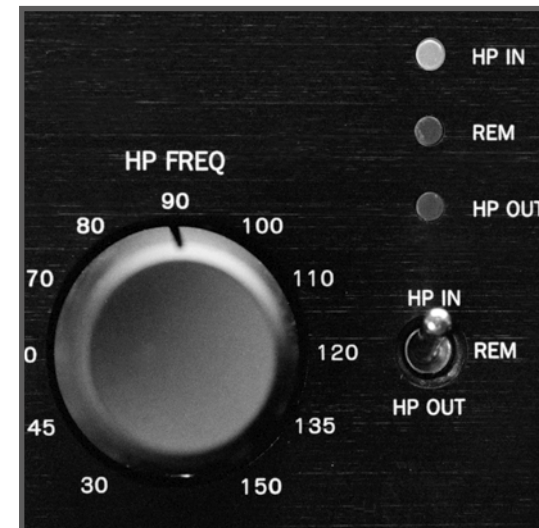
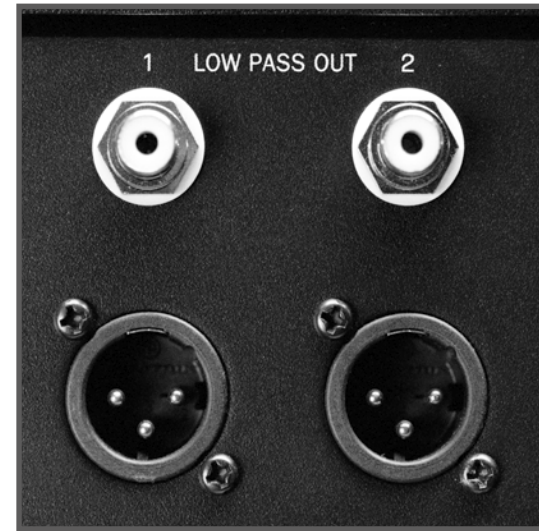



The controller directs the summed stereo channels to a single subwoofer or to multiple subwoofers used in conjunction with the controller.

On the Controller front panel, locate the switch labeled “BAL,” and “SINGLE.” Select “BAL” for use with balanced cables or “SINGLE” for use with single-ended cables. In the same section of the front panel, locate the switch labeled “PROCESSOR,” “REM,” and “LINE.” Select the “LINE” input. On the front panel, locate the switch label “HP IN,” “REM,” and “HP OUT”. Select “HP OUT.” On the front panel, locate the switch labeled “LP IN,” “REM,” and “LP OUT”. Select “LP IN.”

Proceed to Section 3.1, “Front Panel Setup and Final Tuning,” to continue the setup of your unit.

Utilizing the High Pass Filter

The Controller employs a high quality High Pass Filter as a part of its crossover design. The High Pass Filter can be used to filter bass from the main loudspeakers. This can be desirable in systems where the main loudspeakers have limited bass dynamics or if the main power amplifier is low power.

Note: Make sure the Controller power is off during the connecting process.

On the rear of the unit, locate the Line Level inputs of the Controller. Connect the preamplifier output, left and right, to the Line Level input of the Controller). Use the XLR inputs for balanced cables or the RCA inputs for single-ended cables.

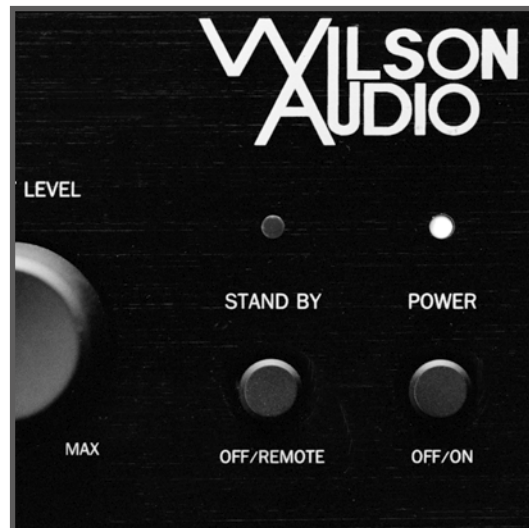

16 Wilson Audio Subsonic Installation Guide

Locate the Line High Pass Output on the rear of the Controller. These connectors pass the high pass section of the signal to your main amplifier for your loudspeakers. Connect the Line HP Output, left and right, of the Controller to the inputs of your power amplifier. Use the XLR inputs for balanced cables or the RCA inputs for single-ended cables.

On the Controller front panel, locate the switch labeled “BAL,” and “SINGLE.” Select “BAL” for use with balanced cables, or “SINGLE” for use with single-ended cables. In the same section of the front panel, locate the switch labeled “PROCESSOR,” “REM,” and “LINE.” Select the “LINE” input.

Locate the switch on the front panel labeled “HP IN” and “HP OUT”. This switch defeats or alternatively engages the high pass filter. Turn the switch to the HP IN position.

Locate the switch on the front panel labeled “HP 6 dB” and “HP 12 dB”. This switch changes the slope of the high pass filter to either 6 decibels per octave or 12 decibels per octave. The position of this switch will be set in its final position in the final tuning stages of the Controller. For now, set the switch to the 6 dB per octave position.

Note: Before proceeding with the Front Panel setup and configuration, please connect your system as outlined in this section, which contains valuable information needed before proceeding further.



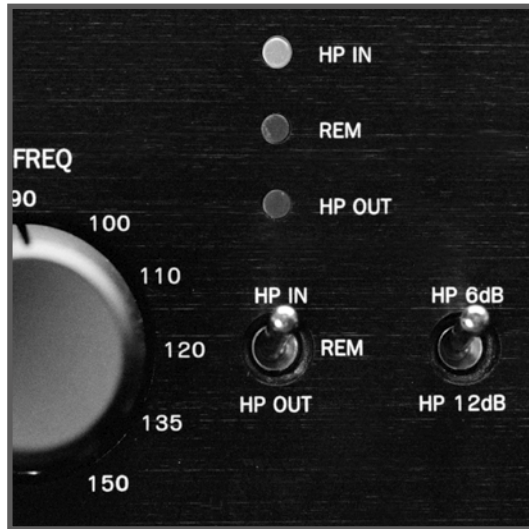



SECTION 3—CONTROLLER FINAL SETUP

Section 3.1—Front Panel Setup and Final Tuning

Preparation

In order to realize the full potential of your Controller, we recommend that you have a trained Wilson Audio Specialist install and perform the final adjustment and setup of your Controller. Wilson dealers are trained in the art of Controller setup. If you choose to do the installation yourself, here are some guidelines to assist you. These guidelines come from many years of experience and should be followed closely to ensure the best possible result from your Controller.

You will need the following items:

- Supplied WATCH Dog Controller Setup CD
- dB Meter
- Pen and paper to make notes

Double check the switch control settings to ensure that they are in the proper positions as outlined in Section 2. In this section, you will be adjusting and fine tuning the Controller front panel.

Locate the main power switch on the front of the Controller. Depress the switch to the “on” position. This powers the Controller into the “standby” mode and can be left on. Locate the STAND BY switch on the front of the Controller. Depress the switch and check to see that the front panel LED is illuminated. This

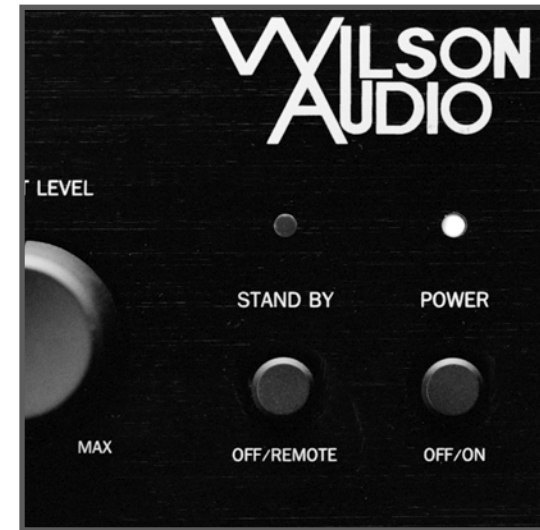

brings the Controller from standby to full power on. Generally, the Controller can be left in the standby off mode when not in use.

Note: We recommend that you turn the main power switch to the off position and disconnect the power cord during lightning storms or when you are away.

Section 3.2—Notes From David A. Wilson on the Test CD

Wilson Audio has provided a test CD to aid you in the setup of your Controller. The following comments and recommendations refer most precisely to the use of the Controller in conjunction with a subwoofer in a two-channel music system. However, these procedures can also be used to optimize the Controller to the left and the right channels of a multi-channel home theater system.

Wilson Audio Subsonic Placement

The Controller possesses sophisticated low pass filter control features as well as the ability to continuously vary phase angle. As a result, placement of the subwoofer is not as critical when used with the Controller. The subwoofer can be successfully placed between and slightly behind the left and right speakers. However, because of the Controller's setup flexibility, the subwoofer can be equally successfully placed in a variety of locations in the listening room - such as on a side wall or behind the listener.

Filtering of LF to the Left & Right Speakers

With two-channel music systems in moderately sized rooms, where high volumes are not required, the left and right speakers are often run full-range. This is particularly true when Wilson Audio speakers are used, as a result of their low distortion and robust power-handling capabilities. The usual rationale for this approach is that the “full-range” signal will lose some of its midrange and high frequency transparency going through the active high-pass crossover. While this is theoretically true, what is more important is the complex low frequency room interaction that will occur between the subwoofer’s output and the full range output of the L and R channels. This LF interaction is greatly reduced if LF to the L & R speakers is filtered out. For the greatest finesse in music reproduction, you should experiment with both approaches.

Initial Placement of the L & R Speakers

If both the subwoofer and the main speakers are new to the system, we recommend that the main speaker positions be carefully optimized for overall sound quality before introducing the subwoofer. To prevent equipment damage and facilitate movement, keep the subwoofer out of the listening area during the two-channel setup phase.

The Controller CD contains a variety of test tones to aid you with the setup of your Controller.

1. If your playback electronics have signal level metering facilities, use track 1 (1 kHz tone) to assure equal signal levels to both left and right loudspeakers. The Controller's output level should be turned all the way down.
2. Assure that the left and right loudspeakers are in phase by using track 4, (BLN - bandwidth limited noise). The noise should appear to come from exactly between your left and right loudspeakers.
3. If you have either a spectrum analyzer or a sound pressure level (SPL) meter, you should measure and document the in-room response of your L & R loudspeakers, running full-range, without subwoofer contribution. This will give you a baseline measurement. While you can measure each channel individually, it is more expedient to measure both simultaneously using the (Mono) test signals. Measurement locations for the microphone should include one at ear height at the main listening location. Additional locations could include: two meters on either side of the primary listening position; halfway between the listening position and the back wall. These readings must be averaged together. Expect measurements taken close to walls to show substantially more low frequency energy than those taken near the center of the room. Use the dB-C weighting, or

better yet, if available, the “Flat”/ non-weighted scale of your instrument. See the illustration on the following page, which compares dB-A & dB-C weighting. The more commonly used dB-A scale, on the other hand, is intended to correspond to the ear’s “frequency response” at low SPL and should never be used to calibrate low frequency levels. Please note that, even at 50 Hz, the dB-C scale is still down approximately 2 dB relative to 800 Hz. Don’t be disappointed, therefore, if your dB-C scale measurements show a gradual roll off in the bass. If your measurements follow the profiled roll off, it indicates a very linear speaker/room response. Use track 2 (pink noise) for spectrum analysis measurements. For measurements using a SPL meter, use tracks 6 through 16, (1/3 octave BLN beginning at 200 Hz and going down to 20 Hz). Document your measured results.

Warning: Tracks 17 through 27 are sine wave tones at the 1/3-octave center frequencies. These should not be used to perform in-room frequency response estimates due to gross inaccuracies which will be created by standing waves. Pure tones are included to scan for mechanical resonances and other distortions.

Notes Regarding the Interpretation of Measurements

- Use “slow” meter response ballistics to help average out the reading... and to keep from going crazy trying to read it!

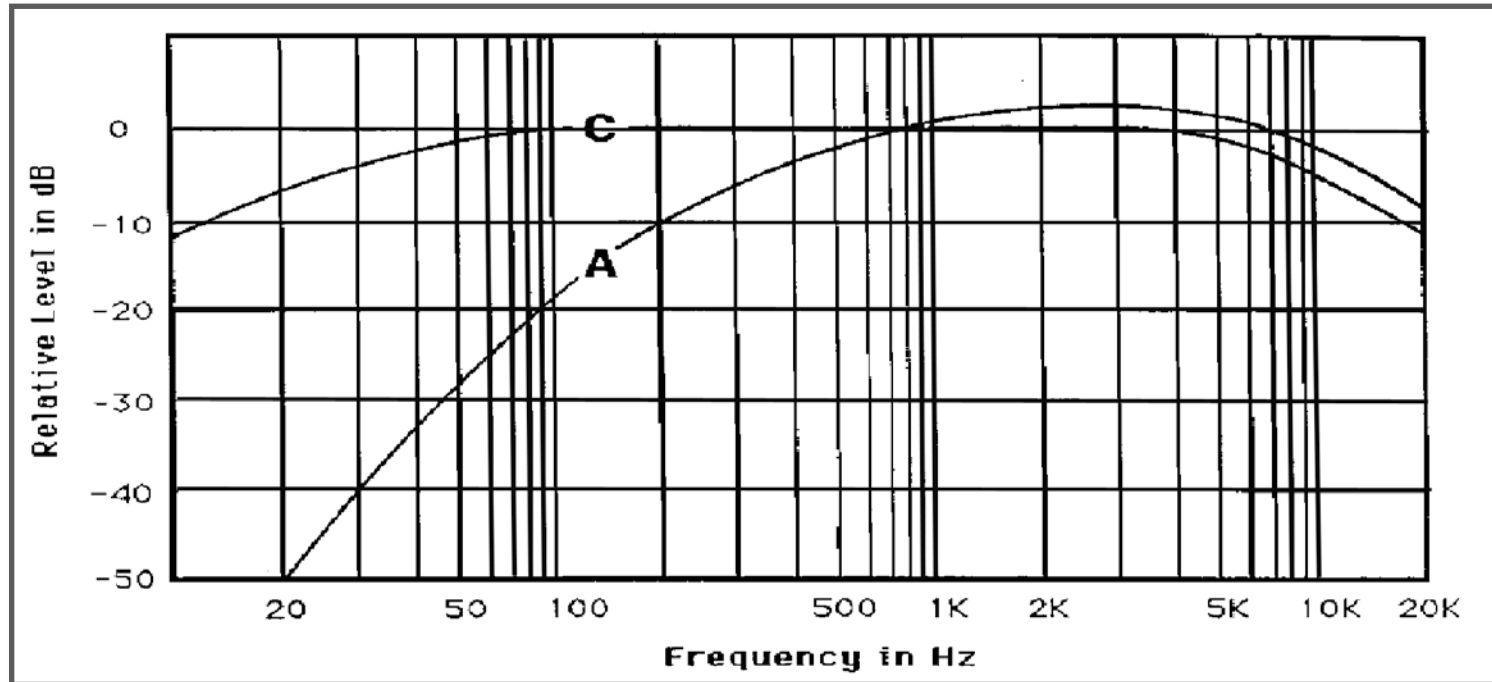

- Ears and meters are not directly interchangeable. They neither sample nor process the sound in a completely analogous manner.

Using the High Pass Filter

If you choose to use the high pass section of the Controller to roll off bass to your main speakers, you can use your measured data to select a low pass (LP) frequency. The suggested setting for the high pass frequency is at the point where the measured frequency curve begins to “roll off,” specifically at the frequency that is minus three to minus six dB (relative to the average

26 Wilson Audio Subsonic Installation Guide

level of the full-range response). If specific measurements are not available, I like to start at 50 Hz with an 18-dB/octave LP slope. I believe that the vast majority of loudspeakers with which your subwoofer will likely be partnered should have enough clean output and power handling in the 40-50 Hz region to allow this approach. However, some rooms exhibit so much loss in the LF that the L & R speakers may have difficulty in that region and need help from the subwoofer up to 60-80 Hz. Another scenario might include problematic room acoustics, with a significant upper bass peak. In such a case, correction may be achieved by running the Controller up to 120—140 Hz and using its EQ to notch out the room peak. This is one area where acoustical measurements, as described above, are of great benefit.

The Controller into Your System

4. Check to see that the L & R loudspeaker power amps are “Off” or on “Standby.”
5. Ensure that all system cabling is correct and secure. At this point in the set up process, the input switches should be configured properly, according to instructions elsewhere in this manual. It is now time to optimize Level, Phase, and EQ settings.
6. If you are filtering the bass to your L & R speakers, select “HP

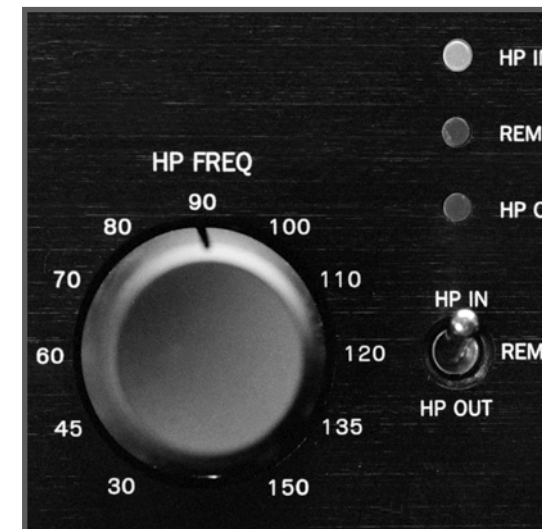
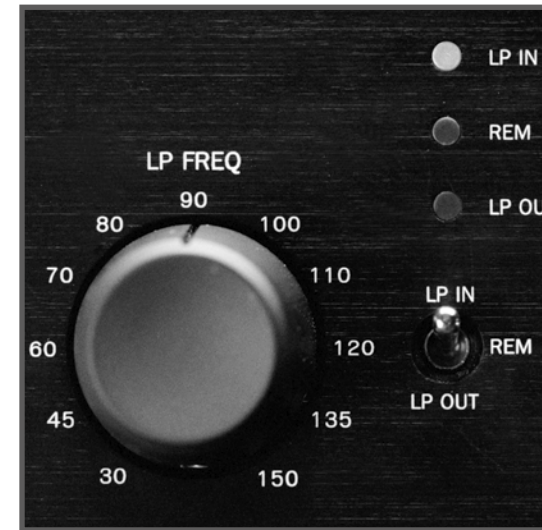



In,” and set the high pass frequency according to the acoustical measurements you have taken. Start with HP at the 12 dB/octave slope.

7. Initially select the low pass frequency 10% lower than the setting for the high pass frequency.
8. Select “LP In” and LP 18-dB/octave slope.
9. Initially set the Phase control at 90°.
10. Select “EQ Out” at this point in the calibration.
11. The output level control should be in the “Min” position.
12. Turn on the program source components and pre-amplification.
13. After two minutes of stabilization time, turn on your Controller.
14. After two additional minutes of stabilization time, turn on your L & R channel power amplifiers.
15. Using track 2 (pink noise), turn the L & R speakers up to 75 dB-C; note the level setting.
16. While the L & R speakers are playing the pink noise, slowly advance the output level control on the Controller until the low frequencies seem to be in balance with the rest of the spec-

trum. If you have a spectrum analyzer, adjust the output level for greatest linearity and extension.

17. Note the output level setting.
18. Next, slowly rotate the Phase control counter clockwise from 90° to 0° and notice how LF levels will change; note the position between 0° & 90° where the LF output is greatest.
19. Repeat this process from 90° to 180°, again noting the position where LF output is greatest. These two settings become your “semifinalists.”
20. Go to track 28. (drum and guitar music) and compare the sound of your two Phase “semifinalists.” Listen for cleaner LF attack and greater weight to select your “winner.” Note the winning setting.
21. Use two tracks, 29 and 32, to establish the WATCH Controller’s upper frequency limit with the LP frequency control setting. What you are looking for is a setting that is low enough to keep from adding artificial chestiness to the male voice in track 32, yet high enough to provide convincing, linear low frequency continuity in track 29. Note the setting.
22. Using the same tracks (29 & 32). and similar listening-judgment

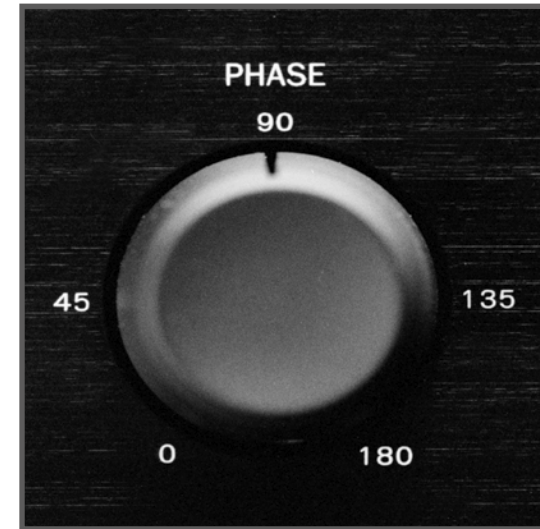

criteria, optimize the setting of HP frequency control, which establishes the low frequency limit of your L & R speakers. Note the setting.

23. At this point in the process, it is instructive to measure the acoustic response of the combined L & R system a second time, but this time with the addition of the subwoofer. Compare the results of this measurement with your prior measurements made without the subwoofer. Document these new measurements. You should now clearly observe more output below 40 Hz as well as good linearity.
24. Now is a good time to experiment with different filter slopes. Simply follow the same procedures as above, being careful to note all settings. This second experiment can then be compared with the first, using music and measurements. Pick the approach that gives the most satisfying musical results.

To EQ Or To Not EQ

Using equalization (EQ) in order to optimize the performance of a loudspeaker is somewhat like a medicine that, while useful, has serious potential side effects. Carefully and minimally used, it can moderate some serious acoustical problems, with little or no down side. However, applied injudiciously, it will cause more problems than it will cure.

30 Wilson Audio Subsonic Installation Guide

The EQ circuitry in the Controller operates only in the Low Pass (LP) function; i.e., it only EQ's the Controller. Therefore, it will have no direct effect on the L & R (or other channel) loudspeakers.

Indications for the use of the Controller EQ would include the following:

- A large LF peak caused by compounded room modes or interaction with a nearby boundary. Corner placement of the subwoofer is more likely to excite modes than a placement at least one meter from a corner.
- A significant narrow dip in LF response caused by acoustical losses in the room. These bass dips can be caused by tall ceilings, openings such as windows and doors (particularly near corners or at the middle of a long wall), or a small, non-load-bearing wall, which acts as a panel resonator bass trap.

These anomalies would show up in the measurements that you have taken above.

25. Set the EQ level control at its "12.00" position, indicating zero gain.
26. Set the switch to "EQ In."
27. Set the "EQ Freq" to correspond with where you believe the problem frequency is.

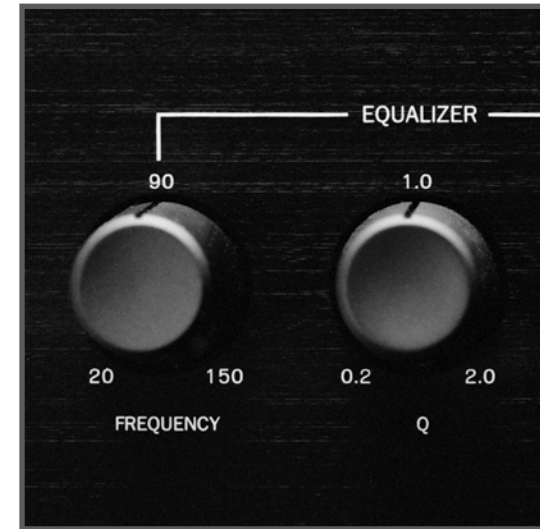

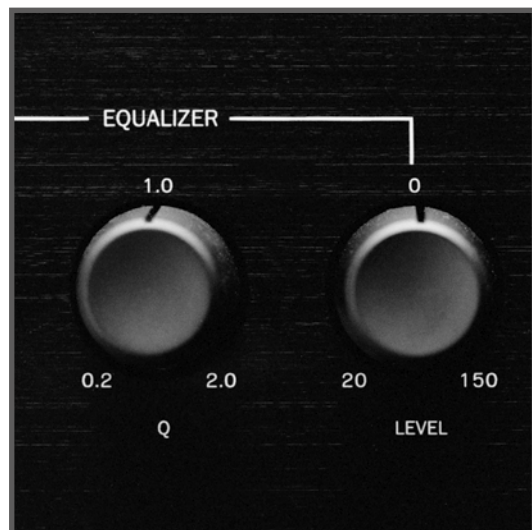

28. Set the “Q” control at its “1.0” position.
29. Depending on whether the acoustical anomaly is a LF response peak or a dip, either cut or boost the EQ with the EQ level control. If you use track 2 (pink noise) and a spectrum analyzer, you can make these adjustments and see (as well as hear) the results in real time. If you do not have a spectrum analyzer, you can still listen to the changes in pink noise. Adjust for greatest smoothness, then measure and document your results.

It has been my experience that making adjustments in an attempt to achieve perfect flatness of response is misguided. Possibly this is because the test signal (i.e., pink noise) causes a relatively continuous excitation of resonances. This allows the amplitude to build up, appearing in measurements as a large deviation from optimum. A great deal of music, because of its more transient nature, may not cause these non-linearities to build up as much. Hence, the tendency to over correct relative to what the musical signal really requires. Therefore, I suggest correcting about half the amplitude of the peak or dip, documenting your results, then listening to see if it makes more musical sense. Apply corrections only as needed. To quote J. Gordon Holt, “If it measures good, but sounds bad... It is bad.”

Advancing the EQ “Q” control located on the front panel allows you to narrow and sharpen the EQ boost or cut. At the maximum Q setting of 2, the equal-

ization is pretty specific, but can also alter harmonic structures. Turning the “Q” control counter clockwise to 0.2 results in a very broad, less frequency-selective adjustment, which usually will not provide enough specific correction.

Section 3.3—Break-in Period

All audio equipment will sound its best after the components have been broken-in for some period of use. While it should sound quite good out of the box, the Controller will sound its best after approximately fifty hours of play-time.

Section 3.4—Twelve-volt Trigger Controls

Certain features of the WATCH Controller are controllable via a series of twelve-volt triggers. This allows remote control access of these features by outside control systems, Audio/Video Controllers, etc. This provides more convenient and seamless operation of the WATCH Controller within home theaters and complex audio systems.

The twelve-volt triggers are connected via standard DC ports located adjacent to the audio inputs on the rear of the WATCH Controller. The following features can be switched between two states: On/Off (Stand By); Line/Processor; High Pass Filter In/Out; Low Pass Filter In/Out.

To access control of one of these four features via its twelve-volt trigger,

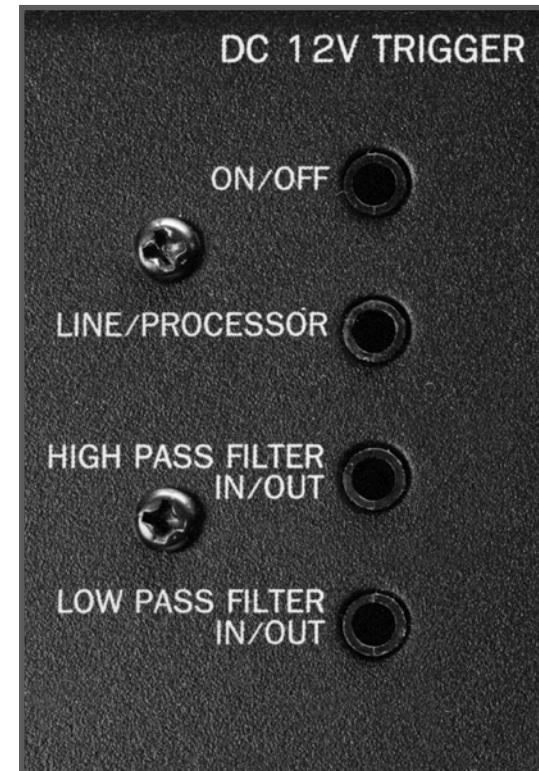

Twelve-volt Trigger Switch Table		
Feature	Zero Volts	Twelve Volts
On/Off (Stand By)	Stand By Mode	On
Line/Processor Input	Processor	Line
High Pass In/Out	High Pass Engaged	High Pass Bypassed
Low Pass In/Out	Low Pass Engaged	Low Pass Bypassed

move the switch corresponding to that function to the “Rem” position. The switches for Line/Processor, High Pass Filter In/Out, and Low Pass Filter In/Out are three position toggles located on the front control panel. If you wish to control any of these features via the twelve-volt trigger, move the corresponding switch to the center position labeled “Rem.” The switch for the Stand By On/Off control is located on the right hand side of the front panel. Leave this switch undepressed when controlling this function via the twelve-volt trigger.

Please Note: Only the switches relevant to the features to be remote controlled should be switched to the “Rem” position. Toggling the switch to the remote position without a twelve-volt trigger connected to that switch will potentially result in your WATCH Controller being improperly configured. The trigger switch defaults to the zero-volt position with nothing connected.

34 Wilson Audio Subsonic Installation Guide

The trigger is designed to be attached to two-state, relay switches which toggle between zero volts and twelve volts. Several Audio/Video controllers feature twelve-volt relay triggers, the status of which are associated with selected modes. These can be used in conjunction with the WATCH Controller relay switches to configure your crossover ideally for those corresponding modes. Similarly, control systems such as Crestron, AMX, and others have the option for interfacing with controllable devices via twelve-volt relay triggers. Consult your audio specialist or installer for more details.

The twelve-volt triggers are two-state switches: the presence of zero volts (no voltage) on the input of the trigger switches to one state and the presence of twelve volts on the input, the other. The following table outlines the trigger state of the controllable features of the WATCH Controller:



SECTION 4 — FINISHING UP

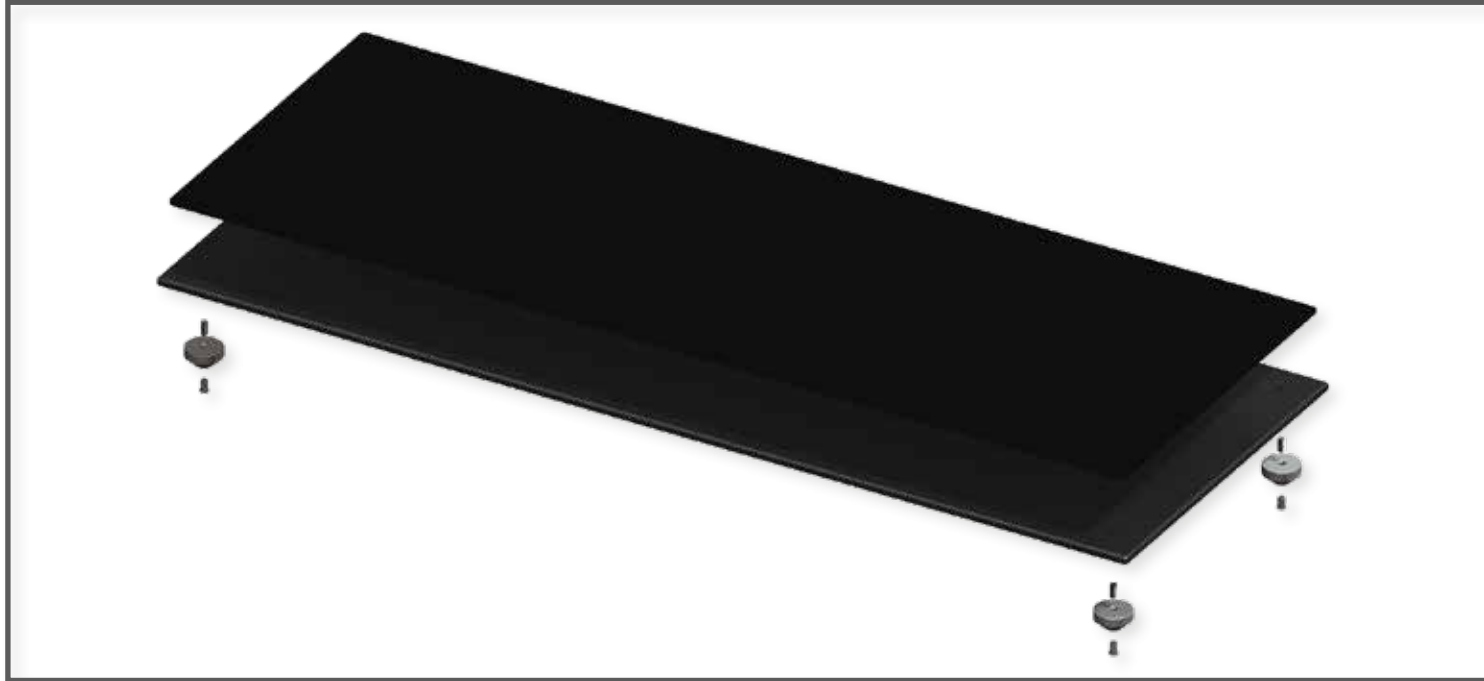

Section 4.1— Spike Installation, Horizontal

The Wilson Audio Subsonic comes with a set of heavy duty spikes that provide acoustical isolation as well as optimal height placement for your Wilson Audio Subsonic. Brass disks that fit beneath the spikes are included for installations where spikes might damage the floor surface (such as wood floors).

Note: Wilson Audio Subsonic weighs over five hundred pounds (226.80 Kg). Two strong individuals are required to safely install spikes.

After determining the Wilson Audio Subsonic's position, assemble the spikes as follows:



Plinth and Spike Installation

Note: Wilson Audio Subsonic is extremely heavy. Three strong individuals are required to safely lay Wilson Audio Subsonic on its side.

A separate accessory plinth is supplied in the event Wilson Audio Subsonic is placed on its side. This plinth features a special padded surface on its upper that provides a degree of protection for Wilson Audio Subsonic's painted surface. Determine the final position of Wilson Audio Subsonic. Make sure to position the Wilson Audio Subsonic such that the binding posts are oriented to the side most convenient to connection. Place the plinth in this location. Assemble spikes by first screwing the spike into the diode. Install the spikes into threaded holes in the bottom of

40 Wilson Audio Subsonic Installation Guide

the plinth.

Note: Remove the casters when tipping Wilson Audio Subsonic on its side. Wilson Audio Subsonic is very heavy—over six hundred pounds (277.60 Kg.)—and can bend or break the caster shaft as the subwoofer rotates horizontally.

Tip the Subsonic onto its side near adjacent to the plinth. Reinstall the casters on the top-side holes. Using the port holes and/or casters as hand grips, carefully tip the Wilson Audio Subsonic up enough that you are able to rotate the subwoofer onto its plinth. The second person should then rotate his side onto the plinth. Ensure the Wilson Audio Subsonic is centered on the plinth. Remove the casters.

Assembly and Care of the Grilles

The Wilson Audio Subsonic's grilles are attached using Wilson's unique austenitic stainless pin system. Each of the three grilles contain four pins. Assemble the grille by screwing each pin into the four threaded holes in each grille. The grille frames are milled from solid "X" material. The threads are tapped directly into the "X" material. Avoid cross threading the grille pins.

Section 4.2—Spike Installation, Vertical

Spike Assembly





- Remove the mechanical diodes and move the nut to about two threads from the point. This will allow for greater movement when leveling the loudspeaker system.
- Screw the spikes into the diode until the nut is against the diode. Be careful that the nut does not turn while inserting and threading spikes into the diode.

Note: Do not tighten these assembled spikes. You will need to unscrew them when you level the Wilson Audio Subsonic.

- Place the set screw into the other end of the diode with the Allen head toward the spike. This will ensure that if for any reason you have to remove your Wilson Audio Subsonic spikes, you will be able to withdraw the set screw safely using the supplied Allen wrench. Screw the set screw into the diode until it meets the spike.
- Place the assemblies out of the traffic pattern until they are needed during the installation.

Section 4.3—Using the Lift to Install Spikes

Materials Required

Note: This is a four person job. Do not attempt this by yourself. The Wilson Audio Subsonic weigh over 600 LBS and may seriously injure someone if

42 Wilson Audio Subsonic Installation Guide

tipped over.

- 8 sets of assembled spikes
- The Wilson Audio Jack
- The jack socket wrench
- Swivel caster wrench

Installation Procedure

1. Slide the Wilson Audio Jack under the front of the Wilson Audio Subsonic, centered between the casters, so that the jack's lift bolt is exposed. Place the lift plate so it is positioned about an inch behind the front facade of the Wilson Audio Subsonic woofer enclosure.

Note: An assistant should stand to the rear of the Wilson Audio Subsonic to steady it.

2. Attach the wrench to the lift bolt and begin to slowly raise the front of the Wilson Audio Subsonic by turning the bolt clockwise.
3. After the front of the Wilson Audio Subsonic is high enough (you will need approximately one and a half inches of clearance beneath the caster), use the swivel caster wrench to loosen the casters. Remove the casters.

4. Insert and screw-in the finished spike assembly. Hand tighten only!

Note: Be very careful not to cross-thread the spikes. The base of the Wilson Audio Subsonic is made of “X” material and can be cross threaded if installed on an angle.

5. With one person stabilizing the Wilson Audio Subsonic, lower the Wilson Audio Subsonic by turning the jack wrench counterclockwise. Note that the Wilson Audio Subsonic will now sit lower in the front as the spike assembly is shorter than the caster. Use caution.

Note: It is very important, at this point, that an able assistant stabilize the front of the Wilson Audio Subsonic until the rear spikes are attached and the unit is lowered. The Subsonic is slightly front heavy, so extra caution should be taken when installing the rear spikes.

6. Repeat the previous process of the caster removal/spike insertion on the opposite side of the enclosure. Then continue the process on the other channel.

Leveling the Wilson Audio Subsonic

7. It is not necessary to use the jack to level the Wilson Audio Subsonic.
8. Place a level on the top of the woofer enclosure from the rear

44 Wilson Audio Subsonic Installation Guide

to check left to right oriented axis. If it is level, move to the next step.

9. If the bubble shows that the speaker is leaning toward the center of the room, you will have to lengthen one of the inside spikes down toward the floor. If the bubble is leaning toward the outside of the room, you will have to lengthen one of the outside spikes down toward the floor.
10. You may rotate the spike tips in place by using a vice-grip or toothed pliers.
11. To find out which spike to lower, grasp the Wilson Audio Subsonic channel and rock it back and forth. This will identify the spike that is out of level from the other three.

Place a level on the front to back oriented axis. If it is level, then your Wilson Audio Subsonic's are level. Using the same process as above, adjust the front or rear spikes to achieve front to back level.

Section 4.4—Removing the Protective Film

To protect the finish of the Wilson Audio Subsonic during final manufacture, shipment, and setup in your listening room, we have applied a removable layer of protective film over the finish. We recommend that this film be left in place until the speakers are in their final location in your listening room. Once



you have determined their final position, remove the film by following this procedure:

1. Ensure the speaker surface is room temperature before removing the protective film.

Note: Removing the protective film when the speaker surface is cold can damage the paint surface.

2. Slowly remove the film from the top down, large sections at a time, gently pulling the film downward and outward.

Note: Tearing the film aggressively can damage the paint.

3. Take care in removing the protective film near edges and corners to prevent paint damage in these areas.
4. The protective film should not be left on the painted surface for extended periods of time nor exposed to heat sources and direct sunlight.



Wilson Audio Subsonic Grills

The Wilson Audio Subsonic's grilles, three total, are attached using Wilson's unique austenitic stainless pin system. Each of the two grilles contain four pins. The grille frames are milled from solid "X" material. The threads are tapped directly into the "X" material. To attach the grille, simply align the pins to the

46 Wilson Audio Subsonic Installation Guide

receptacles, and gently seat the grille until it stops at the end of the receptacle.

If you choose to use your Wilson Audio Subsonic without grills, Wilson provides grommets that insert into the receptacles to cover the grill holes. These are located in the toolkit. Simply press the grommets into the empty grill holes.



SECTION 5 — SPECIFICATIONS

Section 5.1—Specifications: Wilson Audio Subsonic

Enclosure Type: Front Ported

Woofers: 3 each 12 inch, dual spider

Nominal Impedance: 4 ohms

Sensitivity: 87 dB @ 1W @ 1 meter @1 kHz

Overall Dimensions: Height: 65 1/16" (165.25 cm) with spike
Depth: 27 3/16" (69.09 cm)
Width: 18 1/16" (45.87 cm)

Weight: 612 lbs (277.60 Kg)

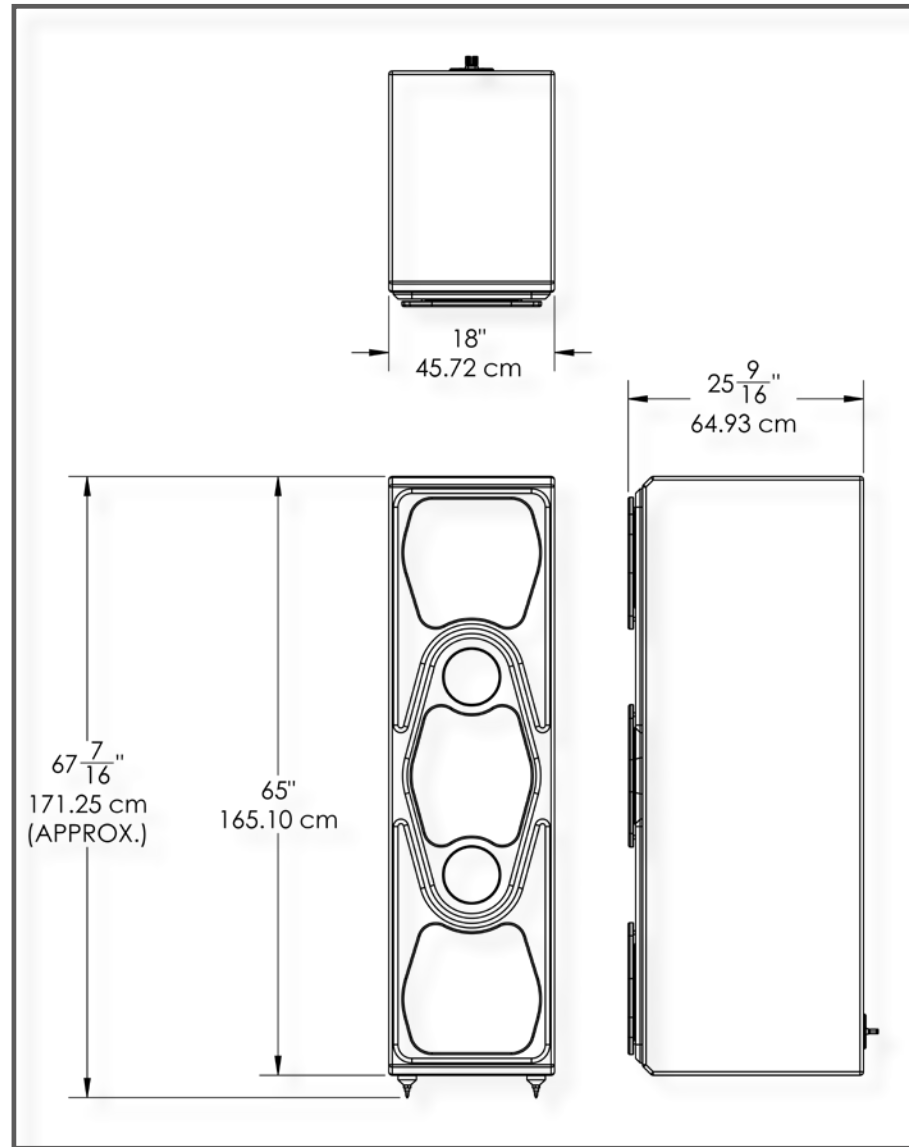
**Section 5.2—Graphical Dimensions:
Wilson Audio Subsonic**

Section 5.3—Specifications: Controller

Input Impedance: 22k ohms single-ended, 50k ohms bal.

Inputs: Balanced and single-ended, Processor

Outputs: High-pass, balanced and single-ended, 2 stereo
Low-pass, balanced and single-ended, 2 mono

Low Pass Filter: Level & Frequency (30 to 150 Hz)
Adjustable, 12 dB or 18 dB/Octave

High Pass Filter: Level & Frequency (30 to 150 Hz)

Phase: Adjustable, 6 dB or 12 dB/Octave

EQ: 0 - 180 degrees, continuously variable
Variable Frequency (30 to 150 Hz)
Level (+/- 10 dB), and Q (.2 to 2)

Dimensions: Width: 19" (482mm)
Height: 4 1/2" (144mm) - Includes feet
Depth: 11 1/2" (292mm) - Includes knobs
Net - 16.75 lbs (7.6 kg)

Weight: Approx. Shipping - 22 lbs. (10 kg)

**Section 5.4—Graphical Dimensions:
Controller**

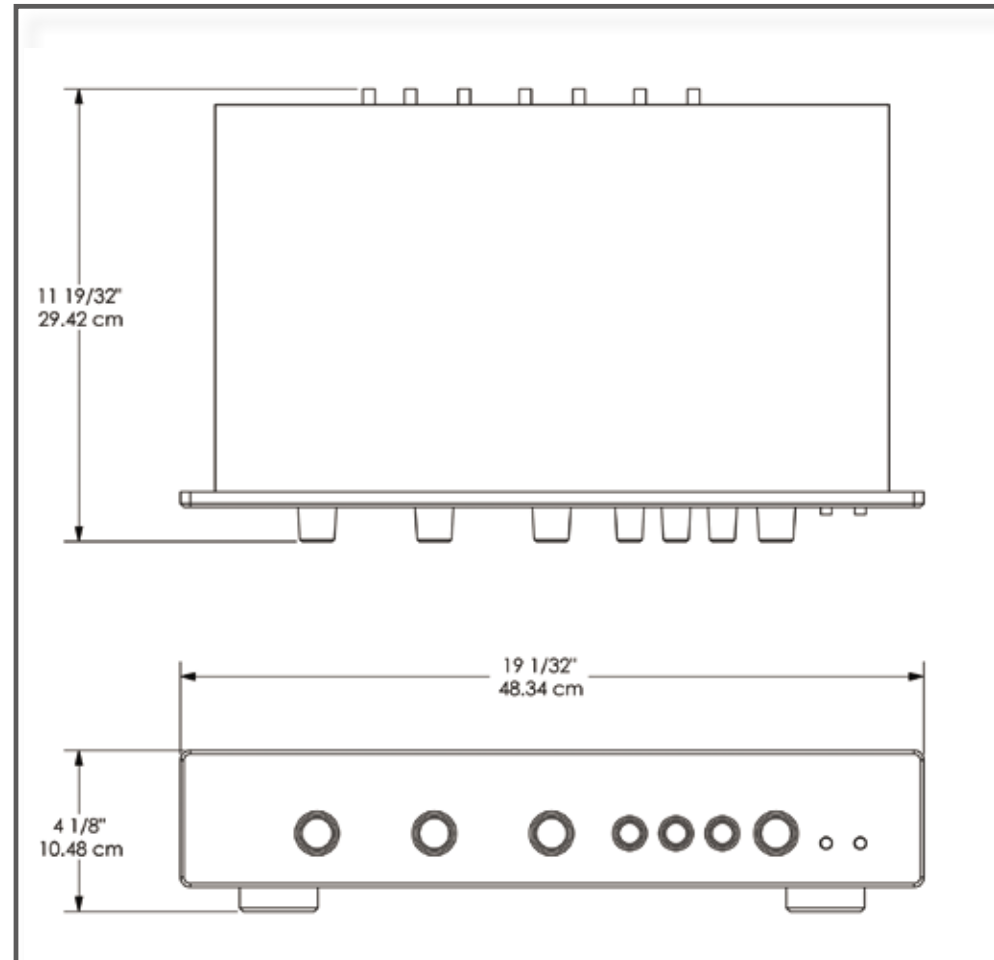



SECTION 6 — WARRANTY

Section 6.1—Limited Warranty

Subject to the conditions set forth herein, Wilson Audio warrants its electronics to be free of manufacturing defects in material and workmanship for the Warranty Period. The Warranty Period is a period of 90 days from the date of purchase by the original purchaser, or if both of the following two requirements are met, the Warranty Period is a period of five (5) years from the date of purchase by the original purchaser:

Requirement No. 1. No later than 30 days after product delivery to the customer, the customer must have returned the Warranty Registration Form to Wilson Audio. Alternatively, the warranty may be filled out on-line.

Requirement No. 2. The product must have been professionally installed by the Wilson Audio dealer that sold the product to the customer.

FAILURE TO COMPLY WITH EITHER REQUIREMENT NO. 1 OR REQUIREMENT NO. 2 WILL RESULT IN THE WARRANTY PERIOD BEING LIMITED TO A PERIOD OF 90 DAYS ONLY.

Section 6.2—Conditions

This Limited Warranty is also subject to the following conditions and limitations. The Limited Warranty is void and inapplicable if the product has been used or handled other than in accordance with the instructions in the owner's manual, or has been abused or misused, damaged by accident or neglect or in

being transported, or if the product has been tampered with or service or repair of the product has been attempted or performed by anyone other than Wilson Audio, an authorized Wilson Audio Dealer Technician or a service or repair center authorized by Wilson Audio to service or repair the product. Contact Wilson Audio at (801) 377-2233 for information on location of Wilson Audio Dealers and authorized service and repair centers. Most repairs can be made in the field. In instances where return to Wilson Audio's factory is required, the dealer or customer must first obtain a return authorization. Purchaser must pay for shipping to Wilson Audio, and Wilson Audio will pay for shipping of its choice to return the product to purchaser. A RETURNED PRODUCT MUST BE ACCOMPANIED BY A WRITTEN DESCRIPTION OF THE DEFECT. Wilson Audio reserves the right to modify the design of any product without obligation to purchasers of previously manufactured products and to change the prices or specifications of any product without notice or obligation to any person.

Section 6.3—Remedy

In the event that the product fails to meet the above Limited Warranty and the conditions set forth herein have been met, the purchaser's sole remedy under this Limited Warranty shall be to: (1) contact an authorized Wilson Audio Dealer within the Warranty Period for service or repair of the product without charge for parts or labor, which service or repair, at the Dealer's option, shall

take place either at the location where the product is installed or at the Dealer's place of business; or (2) if purchaser has timely sought service or repair and the product cannot be serviced or repaired by the Dealer, then purchaser may obtain a return authorization from Wilson Audio and at purchaser's expense return the product to Wilson Audio where the defect will be rectified without charge for parts or labor.

Section 6.4—Warranty Limited to Original Purchaser

This Limited Warranty is for the sole benefit of the original purchaser of the covered product and shall not be transferred to a subsequent purchaser of the product, unless the product is purchased by the subsequent purchaser from an authorized Wilson Audio Dealer who has certified the product in accordance with Wilson Audio standards and requirements and the certification has been accepted by Wilson Audio, in which event the Limited Warranty for the product so purchased and certified shall expire at the end of the original Warranty Period applicable to the product.

Section 6.5—Demonstration Equipment

Equipment, while used by an authorized dealer for demonstration purposes, is warranted to be free of manufacturing defects in materials and workmanship for a period of five (5) years from the date of shipment to the dealer. Demo

equipment needing warranty service may be repaired on-site or, if necessary, correctly packed and returned to Wilson Audio by the dealer at dealer's sole expense. Wilson Audio will pay return freight of its choice. A returned product must be accompanied by a written description of the defect. Dealer owned demonstration equipment sold at retail within two (2) years of date of shipment to the dealer is warranted to the first retail customer to be free of manufacturing defects in materials and workmanship for the same time periods as if the product had originally been bought for immediate resale to the retail customer. Wilson Audio products are warranted for a period of 90 days, unless extended to 5 years, as provided above, by return and filing of completed Warranty Registration at Wilson Audio within 30 days after product delivery to customer and the product was professionally installed by the Wilson Audio Dealer that sold the product to the customer.

Section 6.6—Miscellaneous

ALL EXPRESS AND IMPLIED WARRANTIES NOT PROVIDED FOR HEREIN ARE HEREBY EXPRESSLY DISCLAIMED. ANY LEGALLY IMPOSED IMPLIED WARRANTIES RELATING TO THE PRODUCT SHALL BE LIMITED TO THE DURATION OF THIS LIMITED WARRANTY. THIS LIMITED WARRANTY DOES NOT EXTEND TO ANY INCIDENTAL OR CONSEQUENTIAL COSTS OR DAMAGES TO THE PURCHASER.

Some states do not allow limitations on how long an implied warranty lasts

or an exclusion or limitation of incidental or consequential damages, so the above limitations or exclusions may not apply to you. This Limited Warranty gives you specific legal rights, and you may also have other rights, which vary from state to state.